

EASY PICKINGS

**A SELF TEACHING MANUAL IN THE TECHNIQUE
OF LOCKPICKING**



FULLY ILLUSTRATED & SIMPLE TO UNDERSTAND

PRINTED IN THE U.S.A.

"Easy Pickings"

A self teaching manual in the technique of lockpicking.
For trade purposes only.

Published by

Beckman Associates int

A DIVISION OF C.E.N. INDUSTRIES

ENGLEWOOD, N.J.

Written by

Charles Edward Remington III

Copyright © 1992



All rights reserved. No portion of this book may be reproduced by any means known or unknown without express written permission of the publisher.

Neither the author nor the publisher assumes any responsibility for the use or misuse of the information contained in this book.

LOCK PICK GUNS:

Lock pick guns come in many different forms. Make sure that you purchase one that has an adjustable trigger pull and an oxidized frame. (An adjustable trigger pull is very important so that you can change the speed and torque when you strike the pins upward. An oxidized frame allows a long lasting life and is a sign of a high quality tool.) Generally, with a few hours of practice the gun will open most locks in seconds. I have found through experience that they are clumsy when opening padlocks, but generally work well in most problem situations and also when speed counts.

ACE PICKS:

Ace locks are commonly found on all vending machines, pay laundries and alarm systems. This pick works fantastic, and with a few hours of practice you can open these locks faster than if you had the key. Most Ace picks come with a decoder key so you can make a permanent key once the lock is picked!

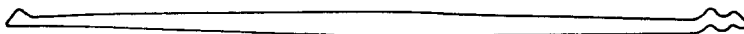

DIAMOND RAKE

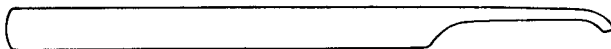

FEELER PICK

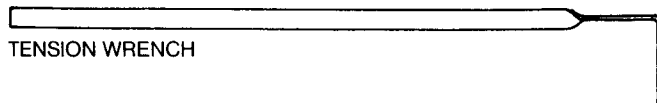

TENSION WRENCH

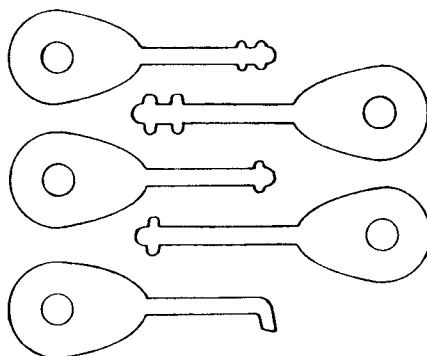

WARDED PICKS

Basic Lockpick Set

HOOK →



DIAMOND →



BROKEN KEY EXTRACTOR →



BASIC RAKE →



DOUBLE BALL RAKE →



BALL RAKE →

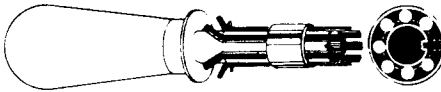

ACE PICK

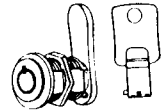

ACE TYPE LOCK

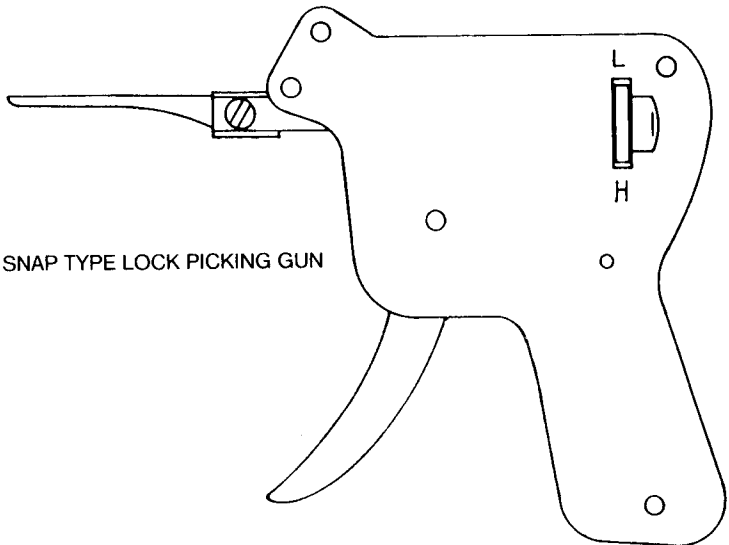

SNAP TYPE LOCK PICKING GUN

UNDERSTANDING THE PIN TUMBLER LOCK

Lockpicking is just one of the many facets of the Locksmith's trade and requires some dexterity, patience, and practice.

We will first start with the construction of a pin tumbler. These are the simplest and most common locks around. Examples of these are Masters, American, Quick Set, etc. I have found that these are the easiest to pick.

To begin you will need the following supplies which can be easily obtained at any hardware store:

- 1) A pin tumbler cylinder
- 2) A small pair of tweezers
- 3) A plug follower or a 1/2 inch diameter wooden dowel will work fine.
- 4) A small vice
- 5) A lockpick set containing tension wrenches (If you have trouble acquiring a lockpick set, one can be purchased easily from the back of this manual.)

In Figure 1 you will see a cut-away view of a pin tumbler lock. Study this picture very carefully and memorize all the parts given.

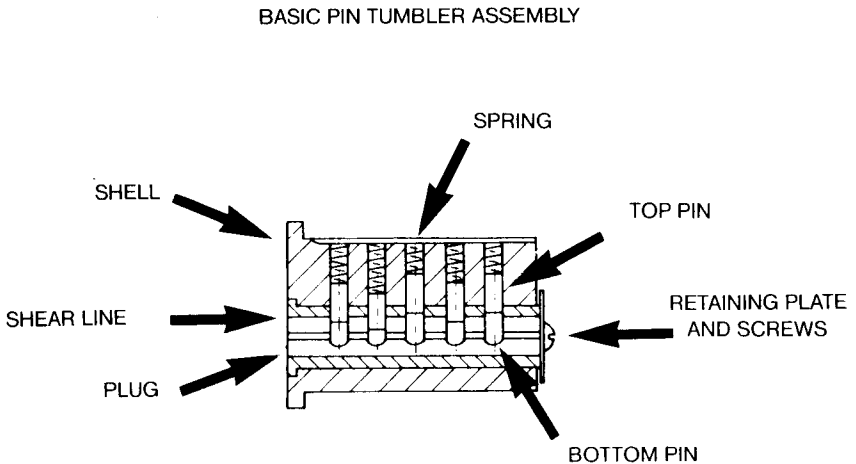

FIGURE 1

You can now begin to take your cylinder apart by first removing the two retaining screws followed by the retaining plate. If your cylinder has a key, insert it, thus bringing your pins to their shear line as shown in Figure 2. The plug may now be removed and pulled out from its shell. As you pull your plug from the front, insert your plug follower from the rear pushing your plug out as shown in Figure 3. It is very important that this procedure is done very carefully so that the springs and the pins do not fly out.

FIGURE 2

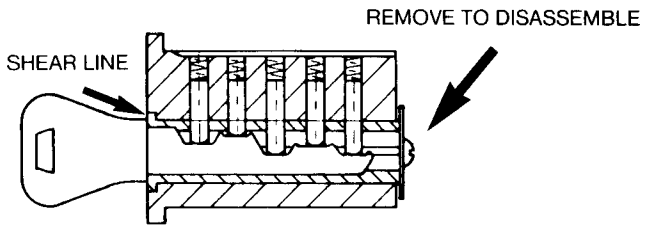
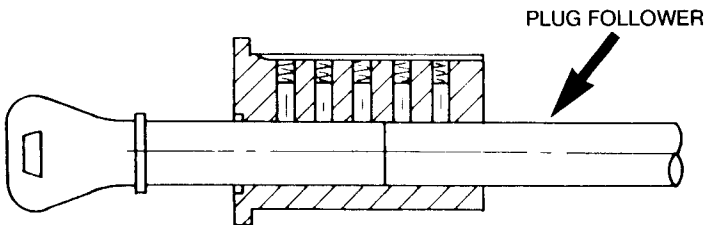

FIGURE 3



You will now see that the bottom pins have remained in the plug while the shell still contains your upper pins and springs retained by the plug follower.

Now very carefully and slowly remove the plug follower and slowly remove each pin and spring one at a time.

If your key was mastered a rather short pin will follow your top pin. These pins can be discarded for now. If your cylidner does not have a key, you can disassemble it by shimming it open as shown in Figure 4. You will need a thin piece of shim stock for this procedure. If you cannot find any shim stock, a .01 spark plug type feeler gauge will work fine. You will also need a feeler pick as shown

FIGURE 4

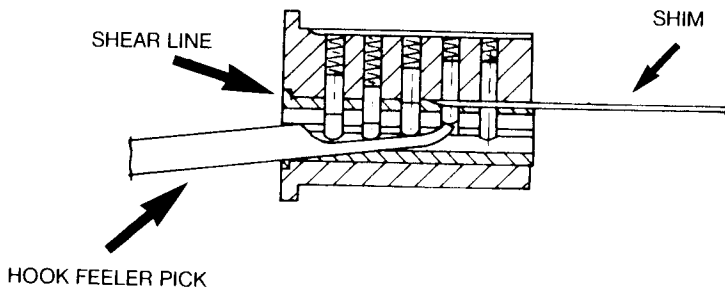

After removing the retaining screw and plate insert the shim in the rear between the plug and the shell. Now insert the feeler pick to the back of the plug, slowly lifting up the rear pin. Once this is accomplished you have found the shear line. Repeat this procedure rear to front until the shim is through the entire shear line.

You may now insert your plug follower and remove the plug as described in the preceding paragraphs.

To reassemble your cylinder repeat this procedure in reverse.

Note if your cylinder has a key and you wish to use it in the future, it is a good idea to mark on a piece of paper the location of each lower pin in the plug.

LET'S PICK SOME LOCKS

You can now set your cylinder for some simple picking practice. First remove your plug from its shell and remove all of the pins and springs except the two rear sets as shown in Figure 5.

FIGURE 5

LOWER AND UPPER PIN ASSEMBLIES

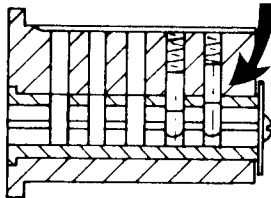

Now place your cylinder in a small vice leaving the location of the keyway accessible. Insert your tension wrench into the bottom of the keyway turning in a clockwise or counter-clockwise motion. The plug will turn in either direction in this type of procedure. Please note however, that when picking a lock in the field you will find that a plug will only turn in one direction.

An easy way to find out the proper direction is to insert the tension wrench and a pick using the pick to force all the pins up. Now apply tension in either a clockwise or counter-clockwise motion. Hold the tension wrench firm and take out your pick and put your ear against the lock. You may now let go of the tension wrench. If you hear the pins drop (a clicking noise), you are going in the right direction. If you hear nothing, then you are turning the plug the wrong way. This procedure should be done any time and every time you pick a lock.

Now with your tension wrench inserted in the keyway you may now insert your feeler pick to the back and gently lifting up the two rear pins at the same time, turn your tension wrench in either direction using very slight force. Once the pins have met the shear line, the tension wrench will swing around and the lock will open. If you have pushed the pins up too far, relax the torsion on the tension and the pins will float down to their normal position. Keep repeating this procedure until the pins have met their shear line.

You may now add more upper and lower pin assemblies to make your practice more difficult.

Once you can do it with all the pins in the plug and shell, you will be able to try more difficult lockpicking techniques. This whole learning experience should not take more than an hour or so.

FIGURE 6

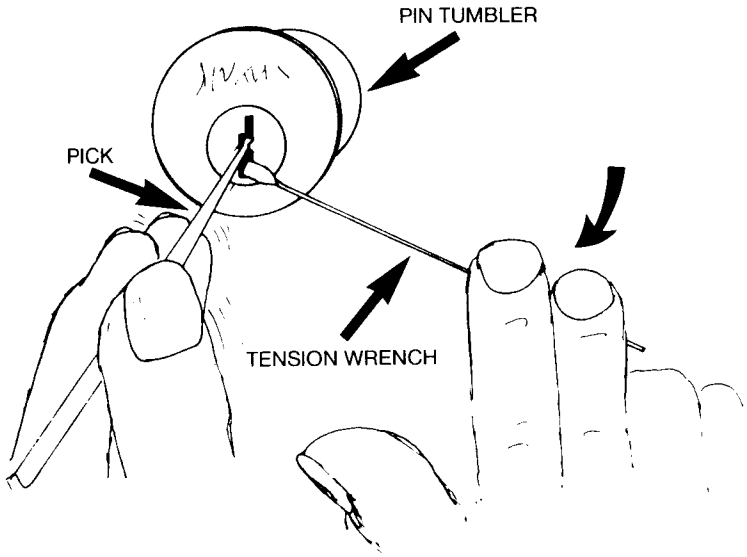

RAKING

Raking a lock is a more advanced way (and usually quicker) of bypassing.

As before, insert your tension wrench in the lower portion of the keyway and insert your rake. Gently glide the rake back and forth with slight torque on the tension wrench. Always make sure that the top knots on the rake are barely touching the bottom pin assemblies on the lock. As each pin hits the shear line, the tension wrench will move ever so slightly. When you have all the pins lined up on the shear line, the tension wrench and plug will swing around and thus presto the lock automatically opens. Try this technique with all the pins in the cylinder.

Another style of raking is called SNAPPING. You will use the Diamond type rake for this procedure. Once again insert the tension wrench in the lower part of the lock. Now do not apply any pressure as of yet. Stick the Diamond rake all the way into the back of the plug until you can feel the last pin. Gently pick up the last pin while applying torque with the tension wrench. Once the wrench moves a little, you have picked that pin. Now in a very quick motion lift up the rest of the pins with the shaft on the rake and pull the pick out as straight and as quickly as possible. Thus snapping all of the pins above their shear line.

As the pins come back down start to apply a pulsating torque on the tension wrench. This will allow all the pins to line up at once. Thus creating the plug to turn and the lock to open. I do not recommend this procedure until you have more proficiency in the others. Try a variety of different rakes until you find one or two that are suitable to your picking style.

FIGURE 7

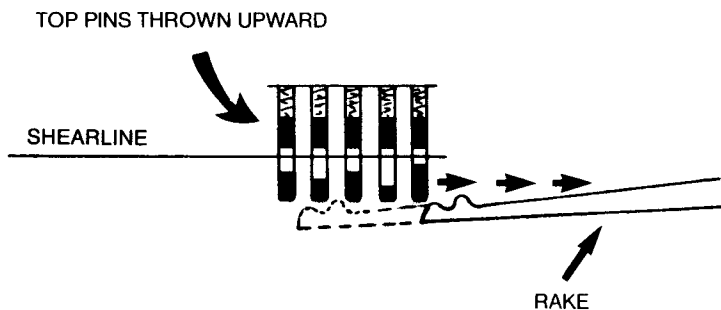

SHORTCOMING

As you are picking, you will notice what is commonly called in the lock a 'Short Coming'. What this means is that due to the tolerance inherited in their manufacturing it would be difficult and expensive for the manufacturer to drill all the holes in a perfect line at the same diameter. What this means is that **ONE OF THE PINS WILL CATCH ON THE SHEAR LINE BEFORE THE OTHERS.** Use this to your advantage.

Using two sets of pins insert your pick and tension wrench and you will see the plug move ever so slightly. Now raise the last pin to the shear line and the lock will open. What this means is that when picking a lock that has five pins one of the pins will catch first. This will remain true for the other four.

A good tip when using your feeler pick is to start from the back. Before adding torque to the tension bar find the last pin and by slowly applying torque with your tension wrench raise that pin to its shear line. Notice that when the tension wrench starts to move "ever so slightly" that the pin has hit the shear line. Now slowly pull the pick out and start with the next pin and raise it to its shear line. The wrench will move a little more. Keep repeating this procedure from back to front until all the pins have met their designated shear line. Thus the lock will open. Note you must never let the tension off the plug or the pins will float back down to their original position and you must start over.

I recommend that you purchase a variety of pin tumbler locks. Some of these should include MASTER padlocks, Quickset, and American padlocks. These type of pin tumbler locks make for excellent picking practice.

Once you have acquired the knowledge and proficiency to pick pin tumblers you should have no trouble as you move on to more difficult locks.

LOCK PICK GUNS

Through the years I have found lockpicking guns to be one of the quickest and fastest way of bypassing the pin tumbler.

On Figure 8 you will see a picture of a basic snap type pick gun. Although lock pick guns come in a very wide range and variety, I have found these to work the best.

Study the illustration given so you will have no trouble as we go along.

First you will notice a knurled wheel at the back end of the tool. This is a tension adjustment of the blow from the gun to the pins. A good tip is to start with the least amount of tension and increase when and if needed.

Now find the proper direction in which your plug turns. Once this is accomplished you may insert your tension wrench. Now insert the picking needle into the keyway making sure the needle is directly under the pins and above the tension wrench. Do not apply any tension on the wrench just yet, see figure 9. You may now squeeze the trigger on the gun and start to apply a slight tension to the wrench. You will knock the pin assembly in an upward motion and into position fast and hard. When the wrench starts to give a little stop triggering and lock will open.

If the lock does not open within seven to nine shots of the trigger, release back a little on the tension wrench and start all over.

FIGURE 9

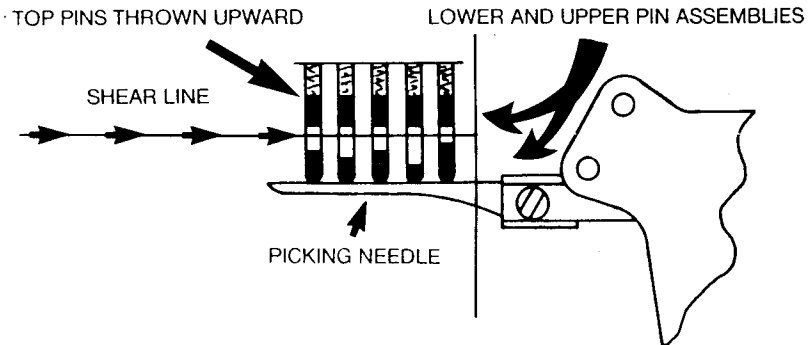
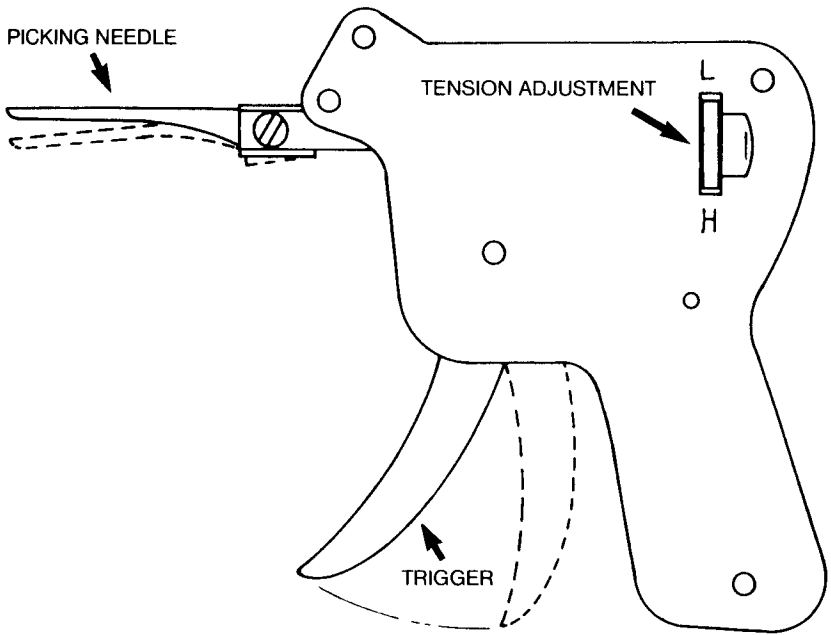

FIGURE 8

LOCK PICKING GUN



HOW TO PICK AN ACE LOCK

Another type of pin tumbler is the tubular lock. They are found on more vending machines, pay laundry machine, and alarm systems.

Do not be fooled by their unusual appearance. These locks are very easy to pick once you know how.

On a tubular lock all of the pins are located radially around the axis of the plug. To pick these locks I will make it as easy as I know how. first you will need an Ace pick. It is about three inches long and tubular with seven feeler picks around its axis and a handle on its reverse end. Note if you have difficulty finding an Ace pick one can be purchased from the back of this book.

Let us begin:

- 1) Make sure the lock is clean and all tumblers are free.
- 2) Slide the fingers back and forth 2 or 3 times.
- 3) Do not pull fingers out from under retainer.
- 4) With fingers flush with end of pick, insert pick into lock as far as it will go. do not apply any torquing pressure at this time. this action raises all the pins in the lock to their extreme height. to pick the lock all the pins must now be moved down to reach their individual shear line.
- 5) Withdraw the pick a few thousandths at a time allowing the pins to move towards the shear line, and at the same time applyng tension by torquing the pick left or right. This action forces the fingers back until the pins are tapped at the shear line, allowing the lock to be opened.
- 6) Do not use excessive force while torquing the lock.
- 7) Make sure the pick is perpendicular to the lock when pickng at all times.
- 8) If any of these fingers has moved all the way back to the cutaway at the end of pick you must start over. This is caused by not holding the pick perpendicular, or withdrawing the pick too far initially.
- 9) When the lock is opened, use a decoder to determine the depths of the pins allowing a key to be made.

FIGURE 10

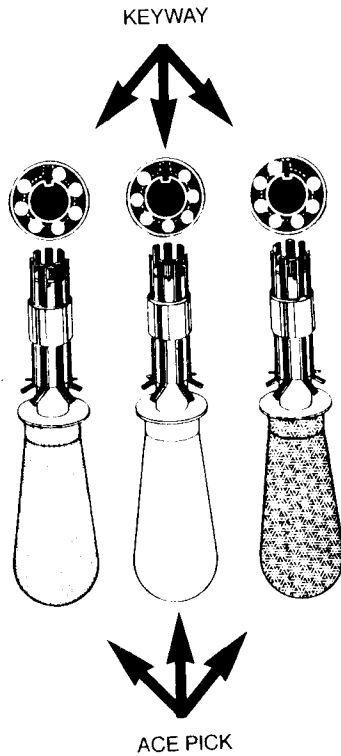
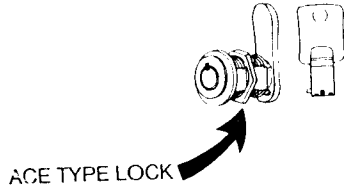

AUTOMOBILE LOCKS

First let me start off by saying that the United States automobile pin tumblers are probably some of the hardest pin tumblers to pick.

Mainly because of the millions upon millions of different configurations when they key the lock. United States automobile manufacturers go down to the tens of thousandths of an inch in their upper and lower pin assemblies, and then incorporate that into a shear line that is about half the thickness of a hair.

If time is your main concern you can pop the plug out with a slidebar hammer and then use a screwdriver to turn the cylinder.

A good tip when using a slidebar hammer is instead of using a screw at the tip try shaving down one of the manufacturer's keys. Example, if you are trying to open GM car use a shaved down GM key.

European and Japanese imports on the other hand are a whole different ballgame. The main reason for this is because imported auto locks are twenty years behind the times. They are manufactured very cheaply and have common tolerances in their keying. From Rolls Royce right down to Toyota. These locks can be picked very easily and very quickly.

There is only one problem when picking these locks. You will need a set of Try Out Keys more commonly known as "JIGGLERS". These picks are very difficult to get your hands on and cost around Fifty Dollars. But if you can obtain a set it's like having the keys to almost every imported car on the road.

JIGGLERS usually come in sets of eight to ten picks and look like double sided keys. They are very simple to use and require little skill and practice and do not require any separate tension tool.

To use these tools simply select the jiggler that most resembles the manufacturer's key. Now you may begin by inserting the jiggler into the key way and apply a little turning pressure in either a clockwise or counter-clockwise motion. Once the pressure is applied push and pull the jiggler out in a raking action. To speed up the opening time try combining the two actions with a little rocking motion. This will increase your chances of fast opening success.

FIGURE 11

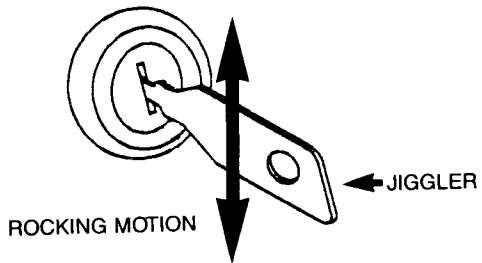
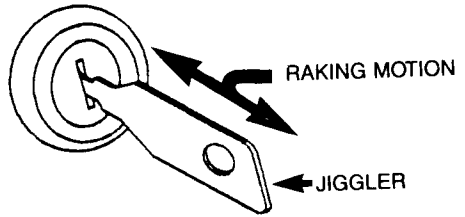
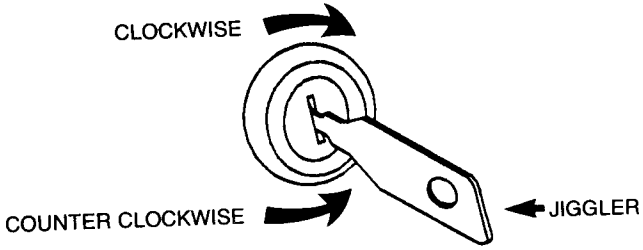
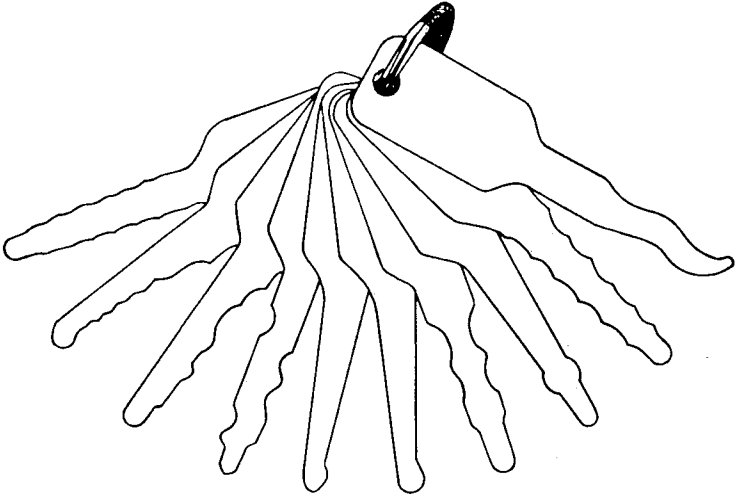
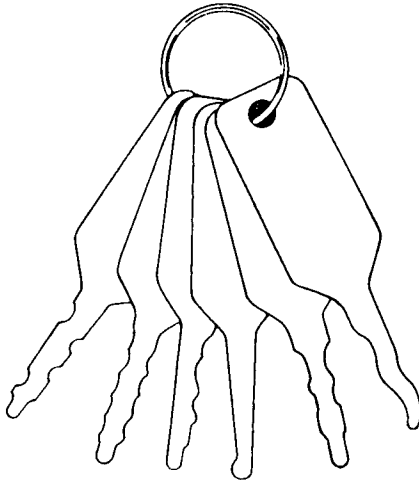

FIGURE 12

FOREIGN CAR TRY OUT KEYS (JIGGLERS)



LARGE SET



SMALL SET

TRICKS OF THE TRADE

In the proceeding text you will learn about different tricks to help you advance in the proficiency of bypassing lock mechanisms.

Let's first start out with the tension wrench. You will most commonly notice that whenever I speak of this device that it must be used with the slightest amount of force. If you have trouble deciphering the amount of force used try this...

You will need a rubber band and a push pin along with your tension wrench. First find the proper direction in which your plug turns. Now approximately three inches from the key way and in the direction that the tension wrench will swing press a push pin into the door. Now twist a rubber band approximately twenty times or before it starts to knot. Wrap one end around the push pin and the other end around the tension wrench. Thus creating a consistently light amount of pressure on the plug. This will enable you to pick or rake the lock in a more proficient manner.

FIGURE 13

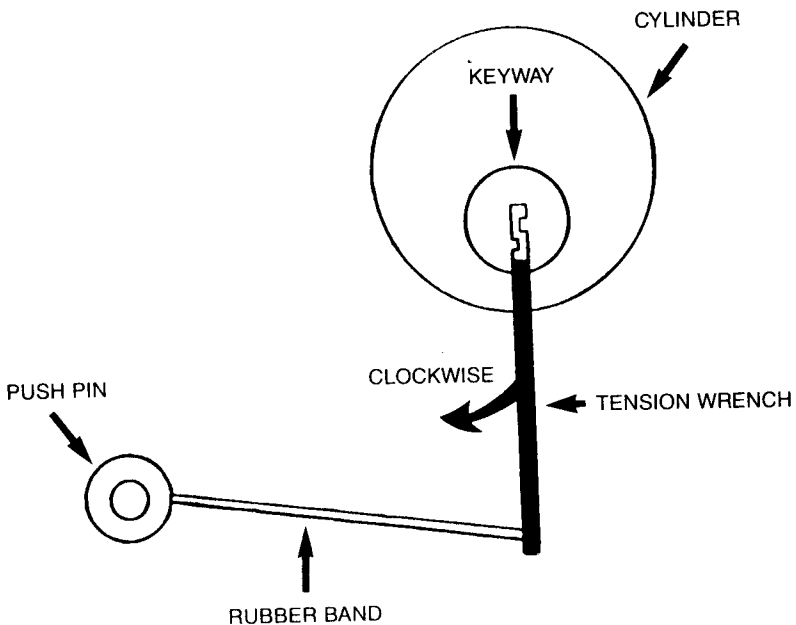

RAPPING: Although padlocks make for interesting picking practice there are other alternatives around bypassing them.

If you do not have picks at your disposal there are other ways. My all time favorite is called "RAPPING". You will need a tension wrench and a one pound hammer will work fine. The theory is to make all the pins vibrate upward by applying a pounding blow to the body of the lock with the hammer. Applying a turning force with the tension wrench at the same time.

FIGURE 14

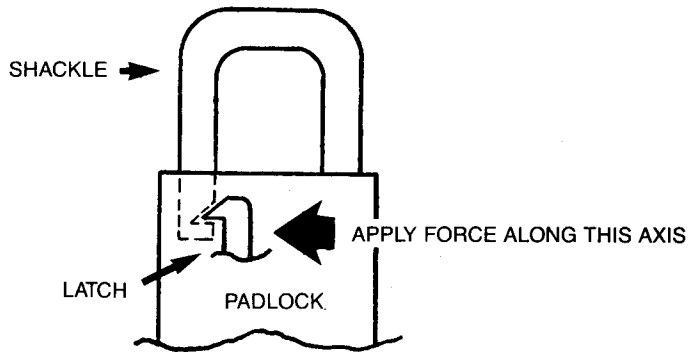
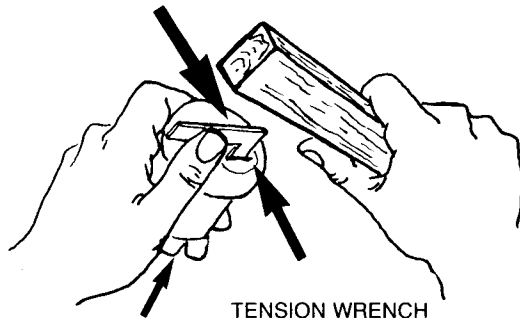

FIGURE 15

APPLY FORCE ALONG THIS AXIS



TENSION WRENCH

BASIC PIN TUMBLER ASSEMBLY

GRAPHITE: Although I do not recommend spraying or injecting any type of lubricant into the plug of a lock, you may have to if the lock is old and weathered.

The reason I do not recommend lubricants is that creates too much friction between the pins, plug and out shell. Thus in time damaging and inevitably destroying the lock. However if you feel a lubricant is necessary I suggest that you use and use only a dry lubricant. Such as powdered graphite. Powdered graphite can be purchased over the counter at any hardware or lock and key shop and should you no more than two dollars or so. It comes in a three inch cylindrical tube with approximately a .005 neck.

This will enable you to place the neck inside the keyway of the lock and squeeze the body of the tube thus blowing the graphite through the entire plug and its body.

In a pinch, if you do not have powdered graphite at your disposal here is what you can do. Fold a simple piece of paper in half vertically and with a sharp number two pencil start grating the lead off the tip and into the fold of the paper. Now place the fold up against the keyway and blow the graphite into the lock. Now you may begin to set your lock to be picked.

Another reason why I do not recommend powdered graphite is if you are the beginning stages of learning how to pick locks it will throw your feel off. Because the lock can be manipulated too easily.

DOOR JAMS: Though this has nothing to do with picking locks this trick will enable you to gain entry and open most doors that do not have a lever latch type lock (i.e. Dead Bolt) by using a common bumper jack and its floor stand.

Place the floor stand flush against the door jam on the side with the hinges. Now place the shaft of the bumper jack into the floor stand. Stretch the jacking mechanism out to the opposite side door jam making sure that the shaft is resting on the door knob. You may now begin to start jacking and stretch the door jams apart. The theory is that the locking bolt will now be separated from the jam of the door. Allowing the door to be opened or allowing enough room between the door and the door jam to manipulate a screwdriver through to pull the locking bolt back into its retaining plate or the body of the lock. Just think, by using a bumper jack the possibilities are endless. If a common bumper jack can lift a thirty five hundred pound car just think what it can do to garage doors, door knobs, windows, etc. Although this creates damaging results, I only recommend this technique in an emergency situation.

FIGURE 16

